

MINIATURE HIGH-POWER LATCHING RELAY

- » 40A switching capability
- » Manual switch function available
- » RoHS compliant

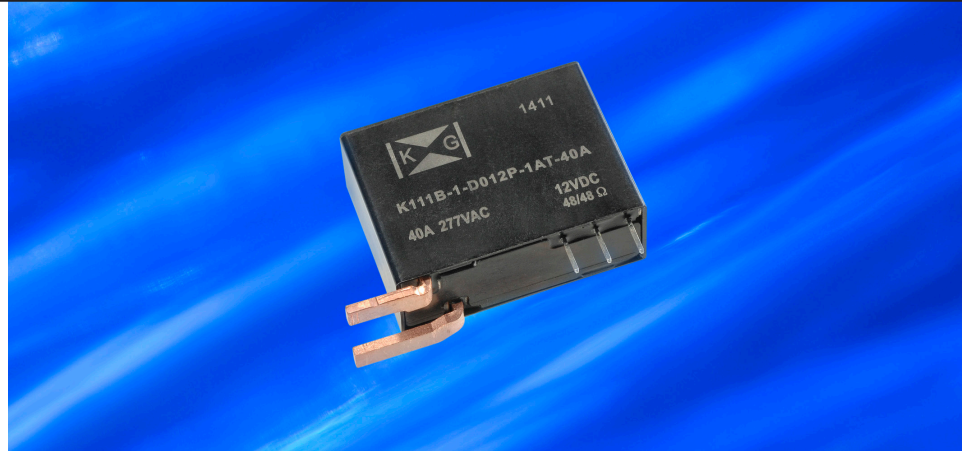

Contact Data [Click here for glossary of terms](#)

Rated load	40A 250Vac
Contact form	1A or 1B
Contact material	AgSnO ₂
Max. switching voltage	250Vac
Max. switching current	40A
Max. switching power	10,000VA (AC switching)
Electrical endurance	100,000 cycles
Mechanical endurance	1,000,000 cycles

Characteristics [Click here for glossary of terms](#)

Insulation resistance	1,000MΩ (at 500Vdc)
Dielectric strength:	
Coil to contact	4,000 Vac for 1 min.
Across open contacts	1,500 Vac for 1 min.
Dielectric creepage	≥8mm
Operating temperature	-40°C to +85°C
Ambient humidity	98% RH, +40°C
Vibration	1.5mm (DA), 10 to 55 Hz
Shock resistance:	
Functional*	10G
Destructive	100G
Unit weight	Approx. 36g
Termination	PCB & QC

* Unit may change state but is still functional.

Coil Data [Click here for glossary of terms](#)

	Single Coil (Latching)	Dual Coil (Latching)
Coil Consumption	1.5W	3.0W
Pulse Duration	Min. 50ms, 100ms to 200ms recommended	Min. 50ms, 100ms to 200ms recommended

Nominal Coil Voltage	Min. Operating Voltage	Max. Operating Voltage	Coil Resistance (Ω± 10%) at 23°C	
			Single Coil (Latching)	Dual Coil (Latching)
6Vdc	4.8Vdc	7.2Vdc	24Ω	2 x 12Ω
12Vdc	9.6Vdc	14.4Vdc	96Ω	2 x 48Ω
24Vdc	19.2Vdc	31.2Vdc	384Ω	2 x 192Ω
48Vdc	38.4Vdc	62.4Vdc	1536Ω	2 x 768Ω

Ordering Information

	K111	A	-	1	-	S	012	P	-	1A	T
Relay Series:											
Terminal Type:	A: See drawings ¹ X: Custom design ²										
Manual Switch:	1: No manual switch 2: With manual switch										
Coil Type:	S: Single coil D: Dual coil										
Coil Voltage³:	6, 12, 24, 48 Vdc										
Coil Polarity:	P: Positive N: Negative										
Contact Form:	1A: Form 1A – NO 1B: Form 1B – NC										
Contact Material:	T: AgSnO ₂										

¹ Other standard terminal type drawings available upon request.

² For custom designs, please contact KG Technologies. Integrated shunts, flex-wire, copper extensions and brass terminals available.

³ Coil voltage should be indicated in three digit format (6Vdc = 006)

Dimensional Drawings

All dimensions in mm unless otherwise noted. For more information, please contact KG Technologies.

A-Style Terminals

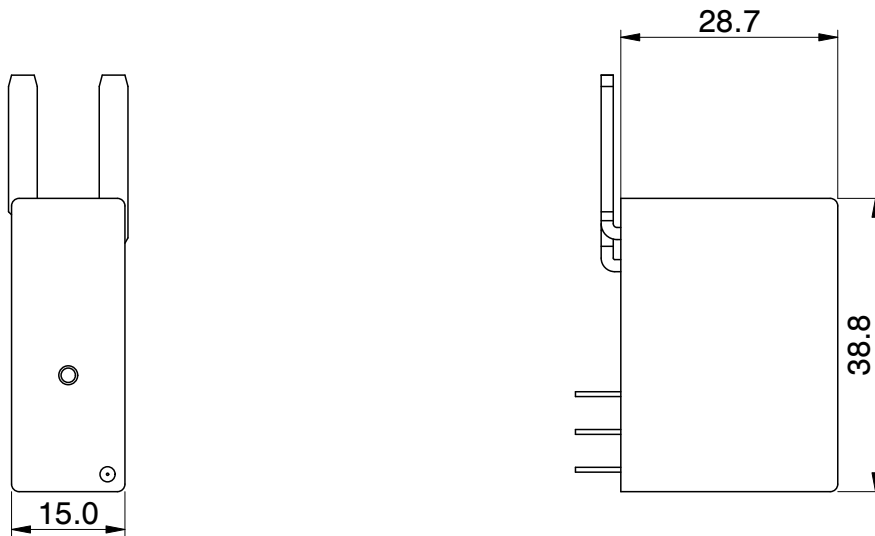

Wiring Diagrams

Dual Coil

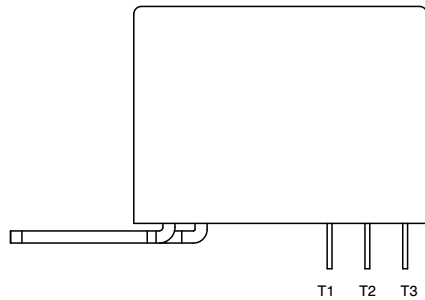

Single Coil

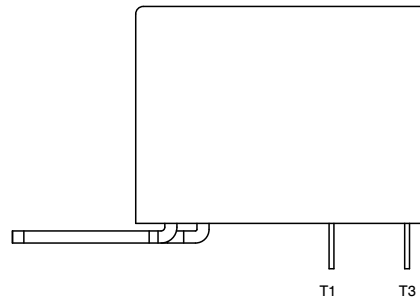

Dual Coil Connection

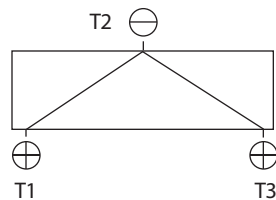

Positive Polarity

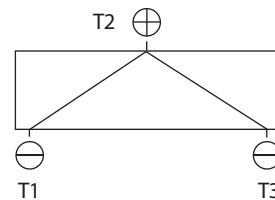

Negative Polarity

Single Coil Connection

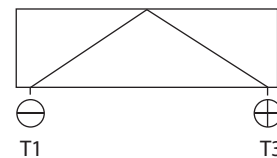

Application Notes

Dual Coil – Positive Polarity: Place a negative connection on T2. Then apply a 50ms positive pulse to T1 to open the contacts or to T3 to close the contacts.

Dual Coil – Negative Polarity: Place a positive connection on T2. Then apply a 50ms negative pulse to T3 to open the contacts or to T1 to close the contacts.

Single Coil: Place a negative connection on T1. Then apply a 50ms positive pulse to T3 to close the contacts. Reversing polarity will open the contacts.

Additional Application Notes

1: All relays are shipped in the “Closed” position. It is possible that during transit or final assembly the relay could change its state to the “Open” position. Therefore, it is recommended that all relays be set to the desired state of the relay via a power supply.

2: In order to maintain an “Open” or “Closed” state of the relay, the coil voltage should reach the rated voltage. The pulse width should be 50ms minimum to ensure a proper change of state. DO NOT energize both T1 and T3 at the same time on a Dual Coil or energize the coil for longer than 1 minute (damage to the coil could incur).

3: Relays without flex-wire cannot be tin-soldered. Moving or bending the terminals could cause damage to the internal structure of the relay.

4: For definitions of terms used in this data sheet, see glossary at www.kgtechnologies.net.

Disclaimer: This data sheet is for reference only. All specifications are subject to change without prior notice. KG Technologies, Inc. cannot predict every possible application for our relays. While we do our best to make our relays as versatile as possible, we highly recommend contacting our engineering team if you have any questions. KG Technologies, Inc. is not responsible for malfunctioning relays when operated outside the specified parameters given in this data sheet.